

# Protistor® size 2x32 and 2x33 aR

400 to 690VAC (IEC) / 700VAC (UL)

## SEMICONDUCTOR PROTECTION FUSES

### SQUARE BODY HIGH-SPEED FUSE-LINKS AC PROTECTION



The 690/700V Protistor® fuse-links provide maximum flexibility in equipment design and ultimate protection for today's power conversion equipment. These square body ultra-fast acting aR fuse-links are available in different body sizes, each size having multiple worldwide acceptable mounting styles.

They have been engineered to provide state-of-the-art protection for semiconductors: diodes, thyristors and IGBT devices. They are assembled with die-cut elements embedded in solidified sand, which helps control arcing characteristics for a lower  $I^2t$  and high interrupting rating level. All contact surfaces are silver plated and all hardware is non-magnetic.

Each fuse-link can be equipped with a low voltage trip-indicator which can operate a field mountable microswitch.

#### TECHNICAL DATA OVERVIEW

Voltage Range AC	400 ... 690 VAC
Ampere Range (A)	800 ... 5000 A
Speed/Characteristic	aR
I.R. AC	130 ... 200 kA
Product Size	2x32 and 2x33

#### FEATURES & BENEFITS

- Multiple body sizes and terminals or blades combination
- aR Class according to IEC 60269-4 and VDE 636-23
- Very low  $I^2t$  for improved semiconductor protection
- Ultra fast acting
- Current limiting
- Superior cycling capability

#### APPLICATIONS

- Protection of inverters, motor drives, UPS systems and similar 690V or less equipments.

#### STANDARDS

- IEC 60269-4 Compliance
- UL/CSA Recognized E76491



MERSEN reserves the right to change, update or correct, without notice, any information contained in this datasheet.

# Protistor® size 2x32 and 2x33 aR

400 to 690VAC (IEC) / 700VAC (UL)

## PRODUCT RANGE

### Size 2x33 type M12 threaded terminals with omega bar

Catalog number	Item number	Rated voltage AC (IEC)	Rated voltage AC (UL)	Rated current I <sub>n</sub>	Pre-arcing I <sup>2</sup> t	Clearing I <sup>2</sup> t at Rated Voltage	Rated breaking capacity AC	Power dissipation at I <sub>n</sub>	Package	Weight
PC233UD69V13CTF	D300268	690 V	700 V	1250 A	159 kA <sup>2</sup> s	850 kA <sup>2</sup> s	170 kA	230 W	1	1.93 kg
PC233UD69V14CTF	E300269	690 V	700 V	1400 A	228 kA <sup>2</sup> s	1200 kA <sup>2</sup> s	170 kA	240 W	1	1.93 kg
PC233UD69V16CTF	F300270	690 V	700 V	1600 A	370 kA <sup>2</sup> s	1900 kA <sup>2</sup> s	170 kA	250 W	1	1.93 kg

### Size 2x32 type TTF M10 threaded terminals with omega bar

Catalog number	Item number	Rated voltage AC (IEC)	Rated voltage AC (UL)	Rated current I <sub>n</sub>	Pre-arcing I <sup>2</sup> t	Clearing I <sup>2</sup> t at Rated Voltage	Rated breaking capacity AC	Power dissipation at I <sub>n</sub>	Package	Weight
PC232UD69V8CTF	T300305	690 V	700 V	800 A	61 kA <sup>2</sup> s	320 kA <sup>2</sup> s	170 kA	144 W	1	1.33 kg
PC232UD69V10CTF	T300213	690 V	700 V	1000 A	111 kA <sup>2</sup> s	590 kA <sup>2</sup> s	170 kA	165 W	1	1.33 kg
PC232UD69V13CTF	V300214	690 V	700 V	1250 A	218 kA <sup>2</sup> s	1100 kA <sup>2</sup> s	170 kA	190 W	1	1.33 kg
PC232UD69V14CTF	G300087	690 V	700 V	1400 A	307 kA <sup>2</sup> s	1600 kA <sup>2</sup> s	170 kA	200 W	1	1.33 kg

### Size 2x33 type PLAF M10 threaded plates

Catalog number	Item number	Rated voltage AC (IEC)	Rated voltage AC (UL)	Rated current I <sub>n</sub>	Pre-arcing I <sup>2</sup> t	Clearing I <sup>2</sup> t at Rated Voltage	Rated breaking capacity AC	Power dissipation at I <sub>n</sub>	Package	Weight
PC36UD69V18CP11	B300427	690 V	700 V	1800 A	515 kA <sup>2</sup> s	2800 kA <sup>2</sup> s	170 kA	250 W	1	2.5 kg
PC36UD60V20CP11	R302235	600 V	650 V	2000 A	682 kA <sup>2</sup> s	3100 kA <sup>2</sup> s	160 kA	280 W	1	2.5 kg
PC36UD60V22CP11	Q302234	600 V	650 V	2200 A	957 kA <sup>2</sup> s	4400 kA <sup>2</sup> s	160 kA	280 W	1	2.5 kg
PC36UD60V25CP11	P302233	600 V	650 V	2500 A	1410 kA <sup>2</sup> s	6600 kA <sup>2</sup> s	160 kA	310 W	1	2.5 kg
PC36UD60V28CP11	N302232	600 V	650 V	2800 A	1855 kA <sup>2</sup> s	8800 kA <sup>2</sup> s	160 kA	330 W	1	2.5 kg
PC36UD55V30CP11	L301977	550 V	600 V	3000 A	1870 kA <sup>2</sup> s	9000 kA <sup>2</sup> s	150 kA	440 W	1	2.5 kg
PC36UD55V32CP11	M301978	550 V	600 V	3200 A	2220 kA <sup>2</sup> s	10800 kA <sup>2</sup> s	150 kA	455 W	1	2.5 kg
PC36UD50V36CP11	N301979	500 V	550 V	3600 A	2880 kA <sup>2</sup> s	12400 kA <sup>2</sup> s	130 kA	465 W	1	2.5 kg
PC36UD50V40CP11	P301980	500 V	550 V	4000 A	3790 kA <sup>2</sup> s	16200 kA <sup>2</sup> s	130 kA	515 W	1	2.5 kg
PC36UD45V45CP11	Q301981	450 V	500 V	4500 A	5000 kA <sup>2</sup> s	18600 kA <sup>2</sup> s	130 kA	560 W	1	2.5 kg
PC36UD40V50CP11	R301982	400 V	400 V	5000 A	7470 kA <sup>2</sup> s	23100 kA <sup>2</sup> s	200 kA	580 W	1	2.5 kg

MERSEN reserves the right to change, update or correct, without notice, any information contained in this datasheet.

# Protistor® size 2x32 and 2x33 aR

400 to 690VAC (IEC) / 700VAC (UL)

## TIME CURRENT CHARACTERISTIC CURVES

### Size 2x32

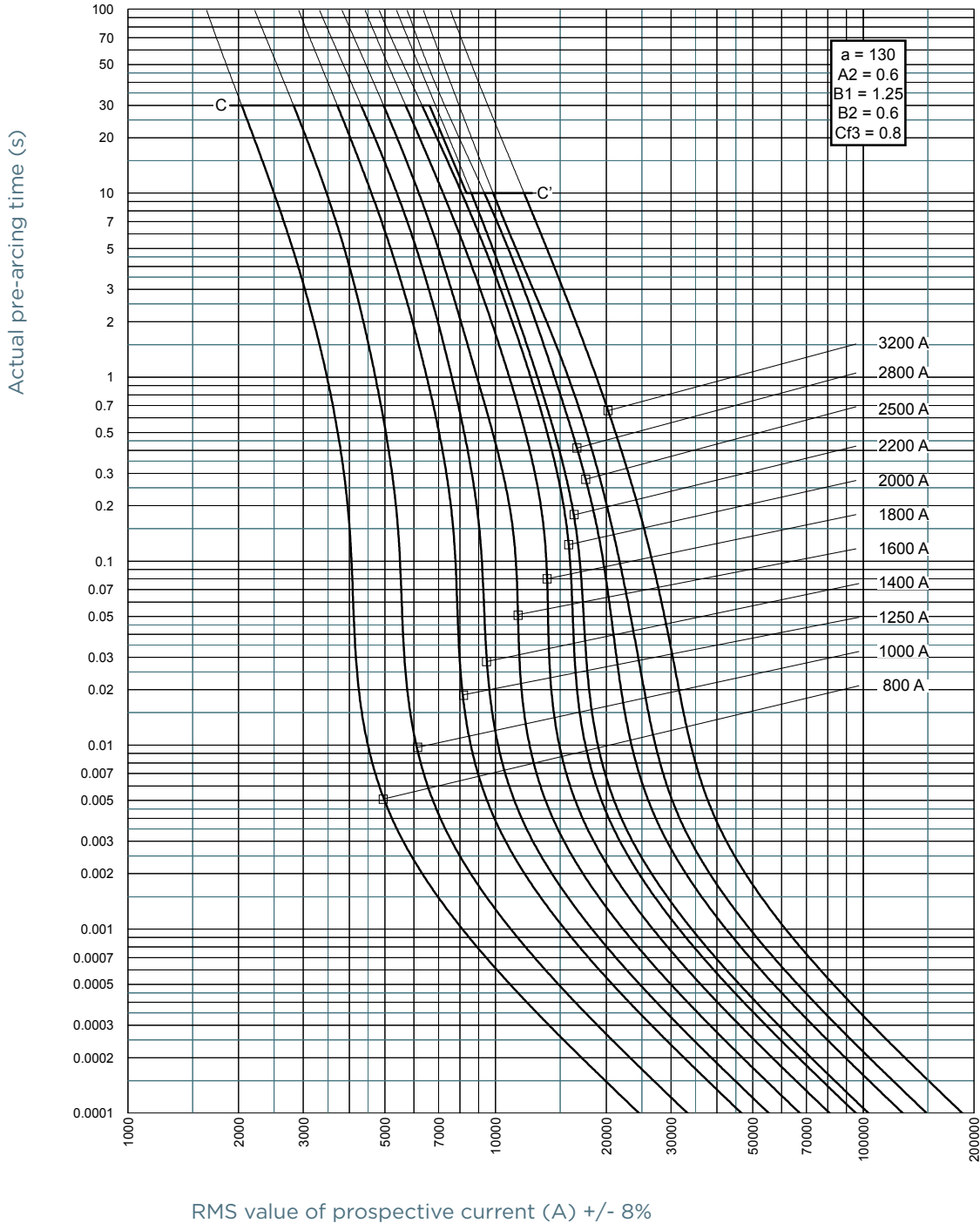

# Protistor® size 2x32 and 2x33 aR

400 to 690VAC (IEC) / 700VAC (UL)

## TIME CURRENT CHARACTERISTIC CURVES

### Size 2x33

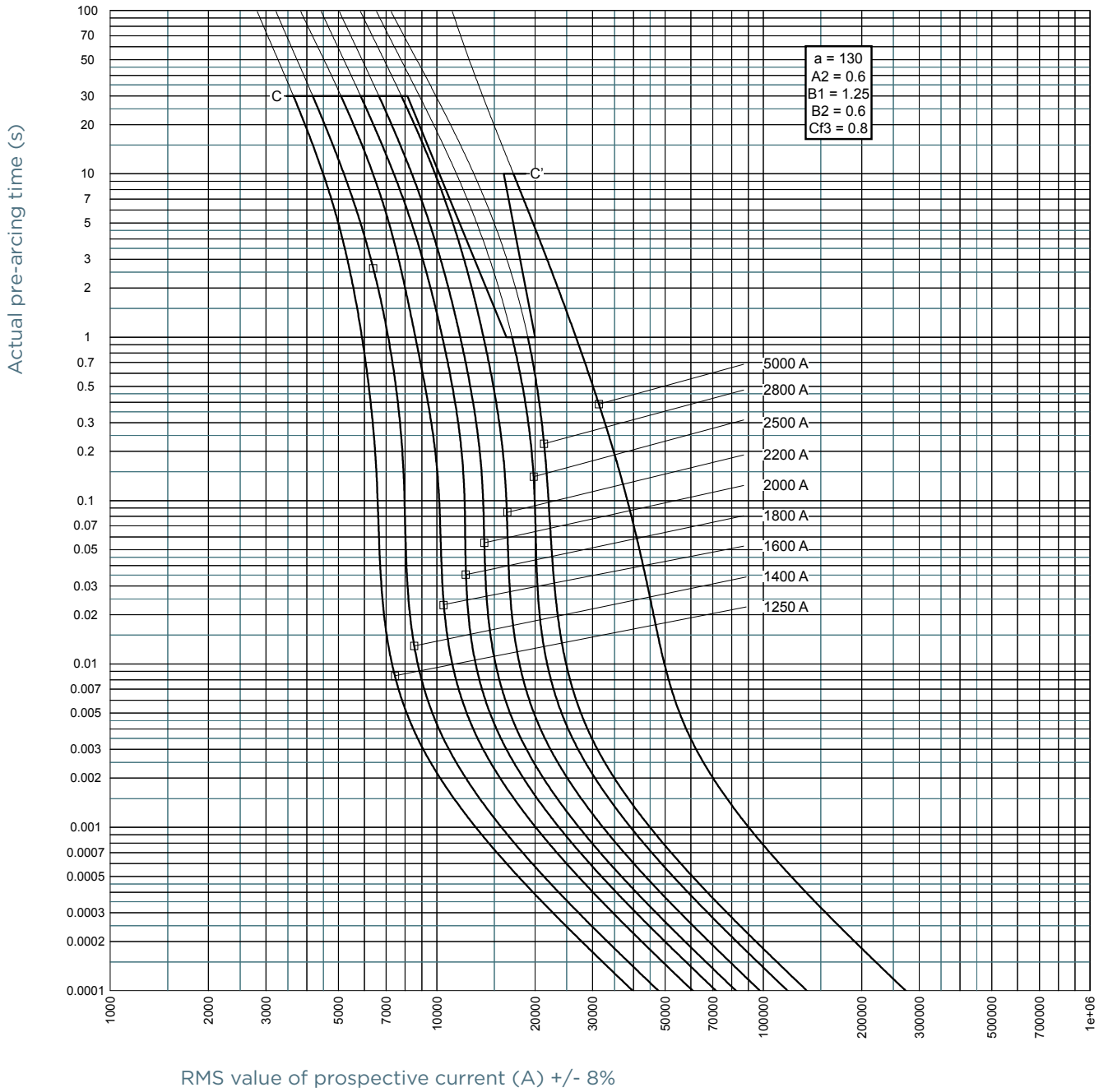

# Protistor® size 2x32 and 2x33 aR

400 to 690VAC (IEC) / 700VAC (UL)

## CUT-OFF CURRENT CHARACTERISTIC

### Size 2x32

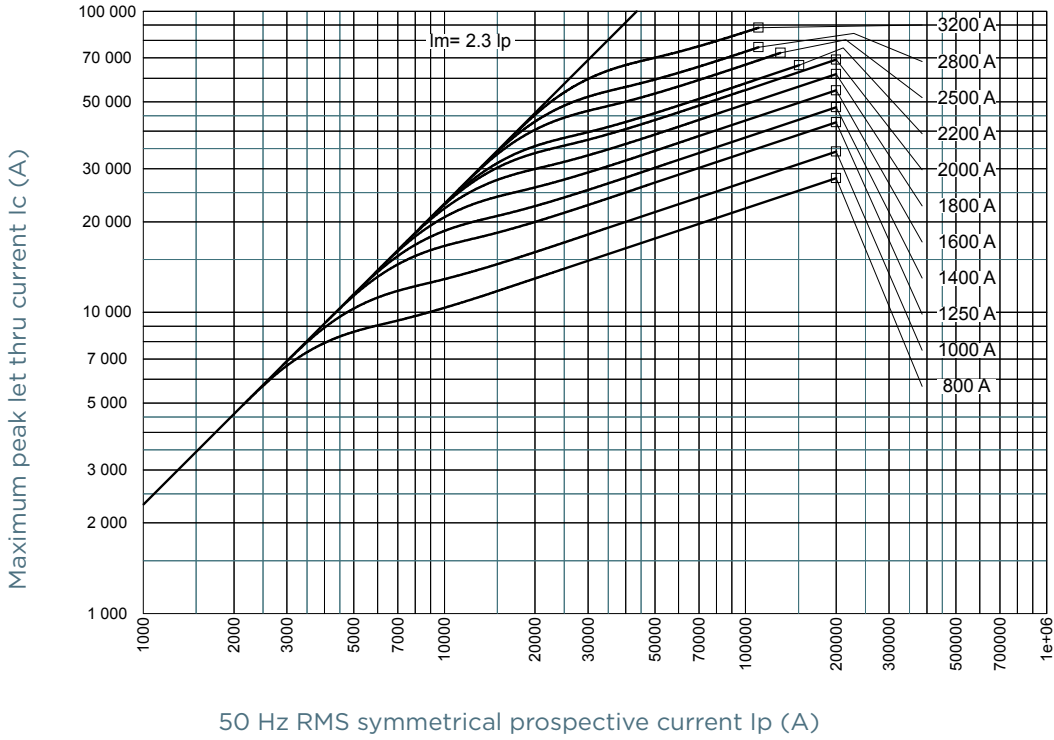

### Size 2x33

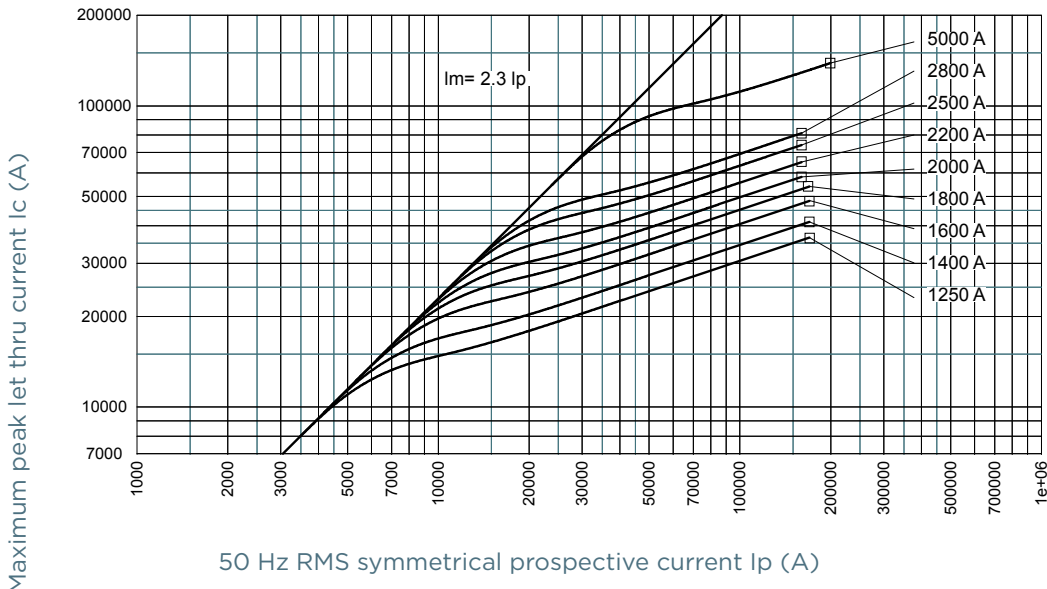

# Protistor® size 2x32 and 2x33 aR

400 to 690VAC (IEC) / 700VAC (UL)

## I<sup>2</sup>T MULTIPLIER COEFFICIENT

### Size 2x32 450V

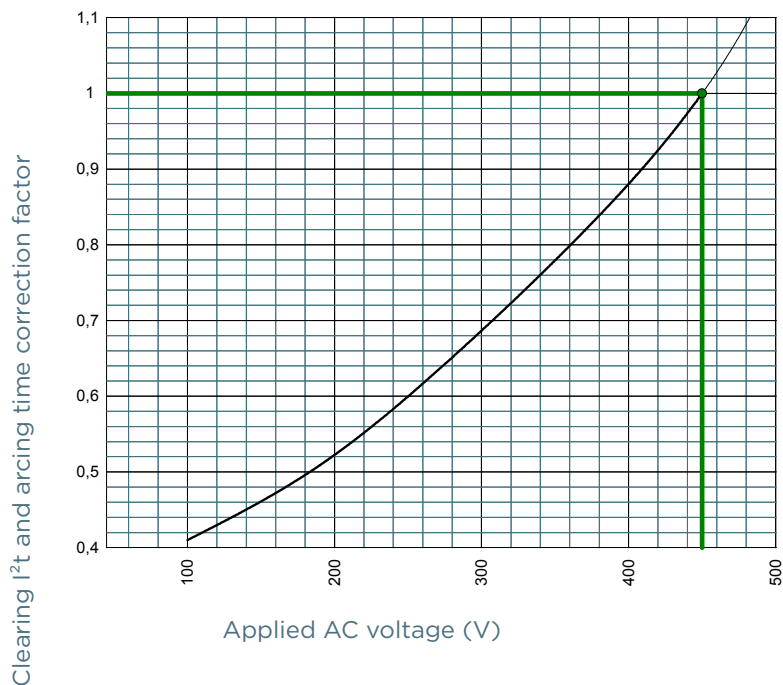

### Size 2x32 500V

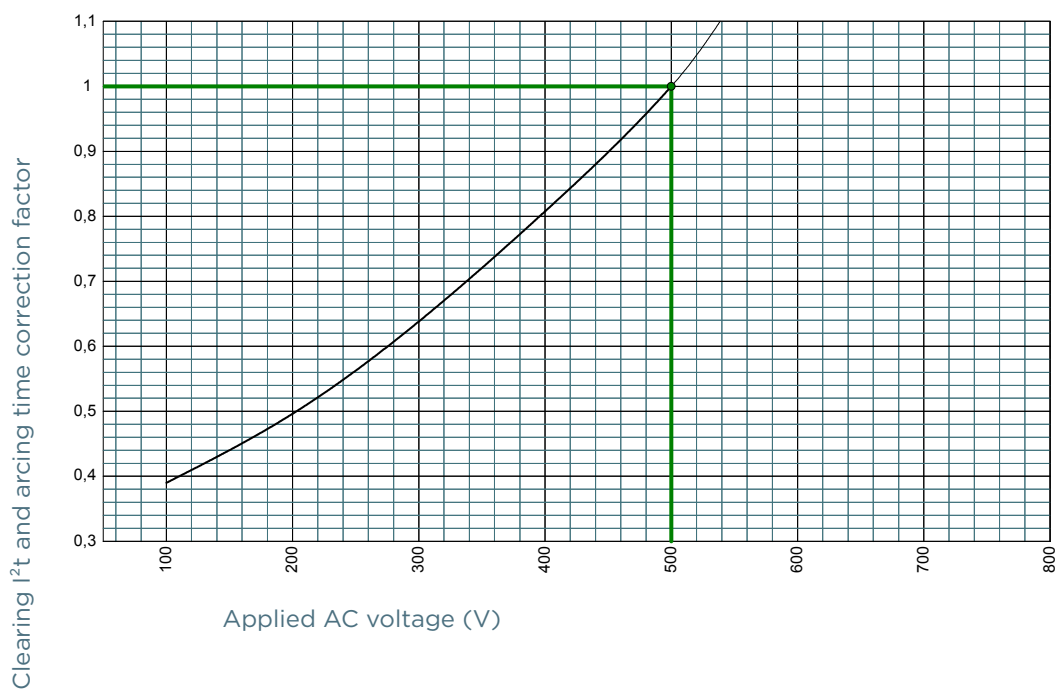

# Protistor® size 2x32 and 2x33 aR

400 to 690VAC (IEC) / 700VAC (UL)

## I<sup>2</sup>T MULTIPLIER COEFFICIENT

### Size 2x32 550V

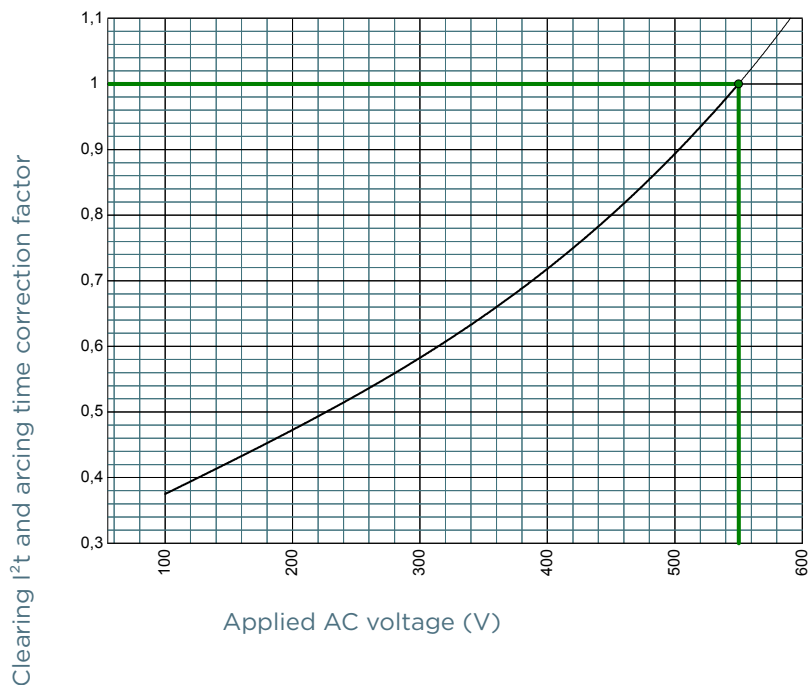

### Size 2x32 690V

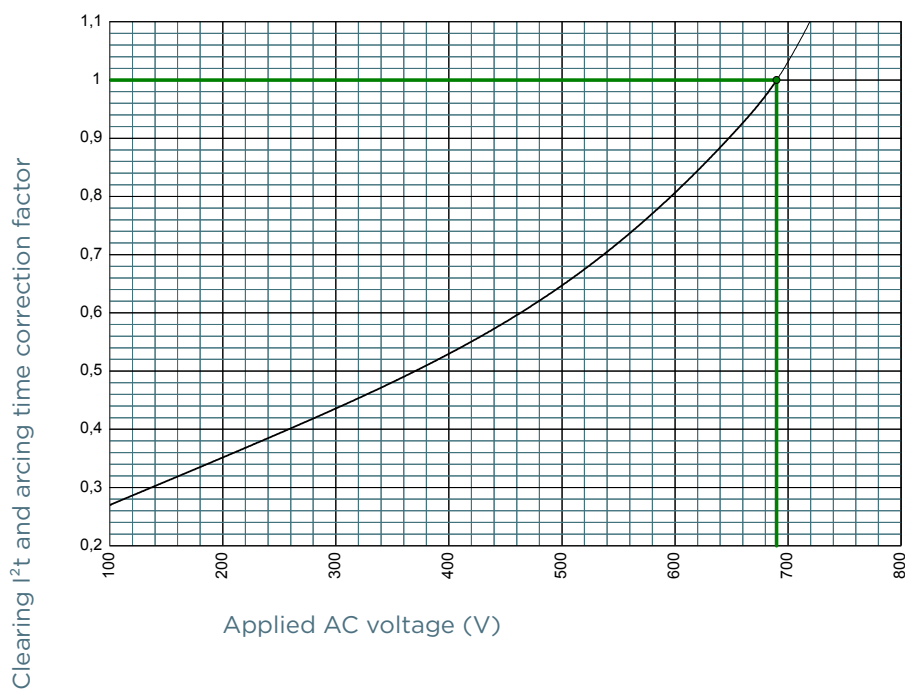

# Protistor® size 2x32 and 2x33 aR

400 to 690VAC (IEC) / 700VAC (UL)

## I<sup>2</sup>T MULTIPLIER COEFFICIENT

### Size 2x33 400V

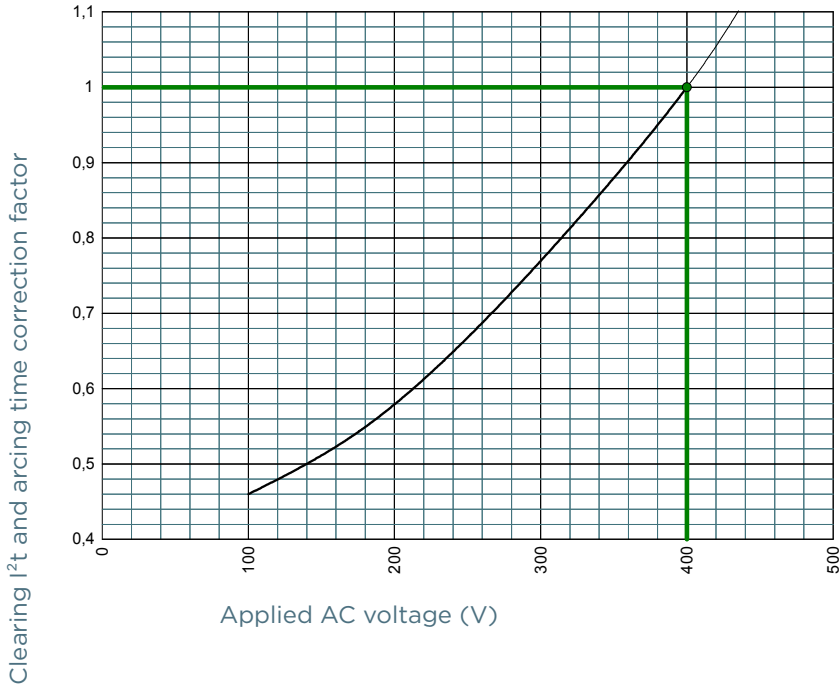

### Size 2x33 600V

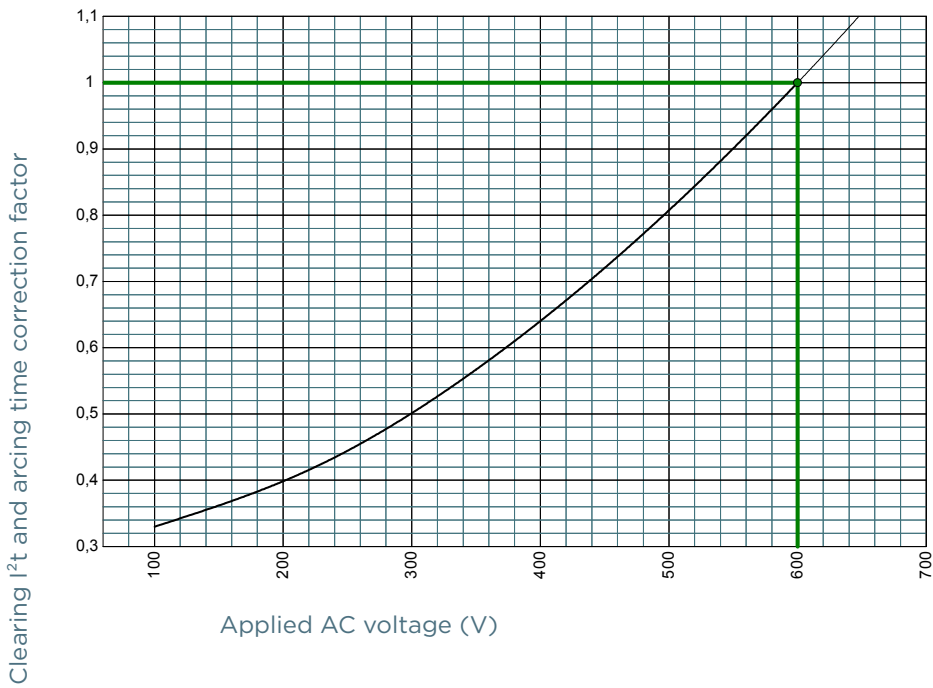



# Protistor® size 2x32 and 2x33 aR

400 to 690VAC (IEC) / 700VAC (UL)

## I<sup>2</sup>T MULTIPLIER COEFFICIENT

### Size 2x33 690V

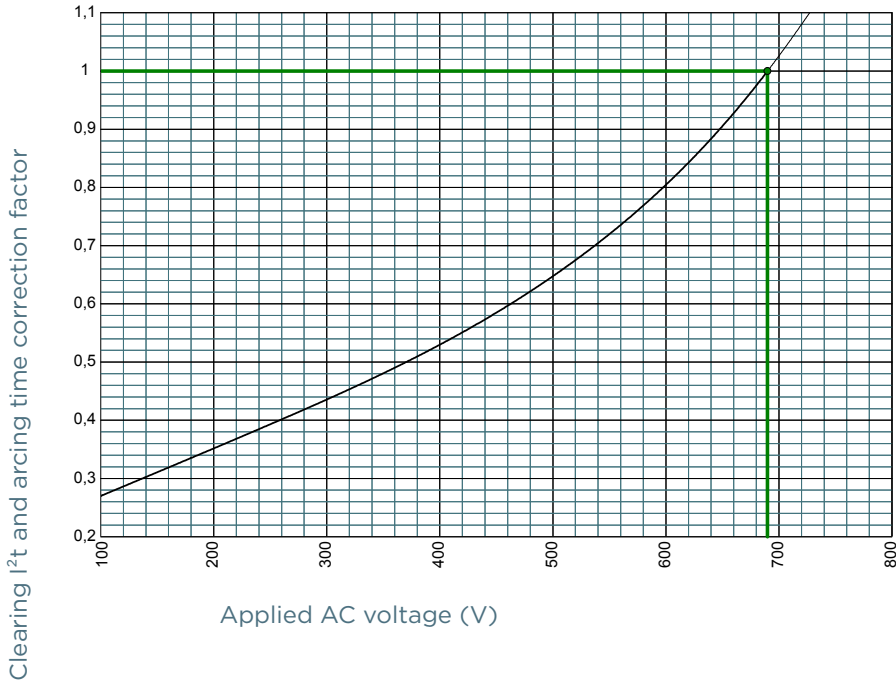

## CHARACTERISTICS TOTAL I<sup>2</sup>T CURVE

### Size 2x32 450V

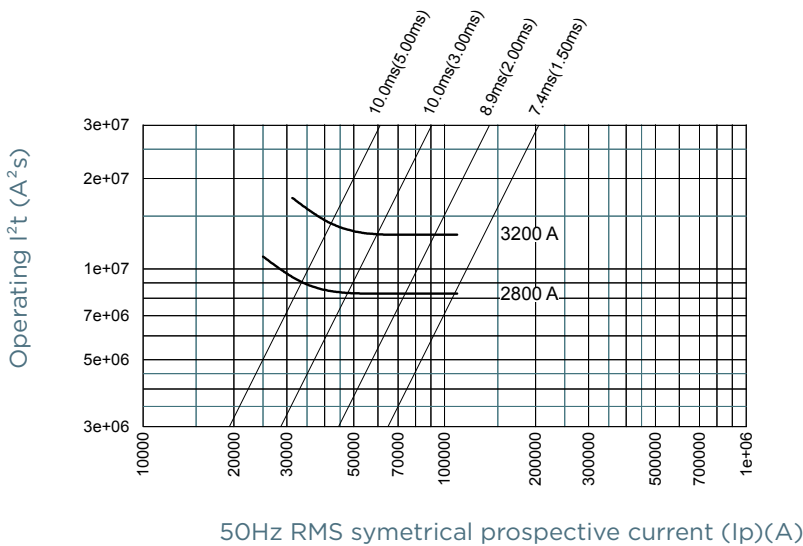

MERSEN reserves the right to change, update or correct, without notice, any information contained in this datasheet.

# Protistor® size 2x32 and 2x33 aR

400 to 690VAC (IEC) / 700VAC (UL)

## CHARACTERISTICS TOTAL I<sup>2</sup>T CURVE

### Size 2x32 500V

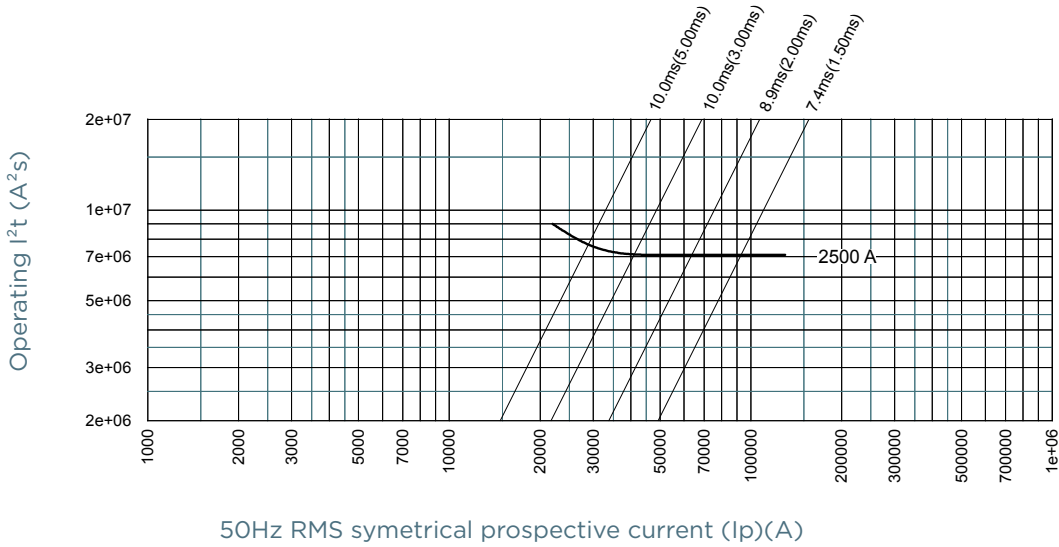

### Size 2x32 550V

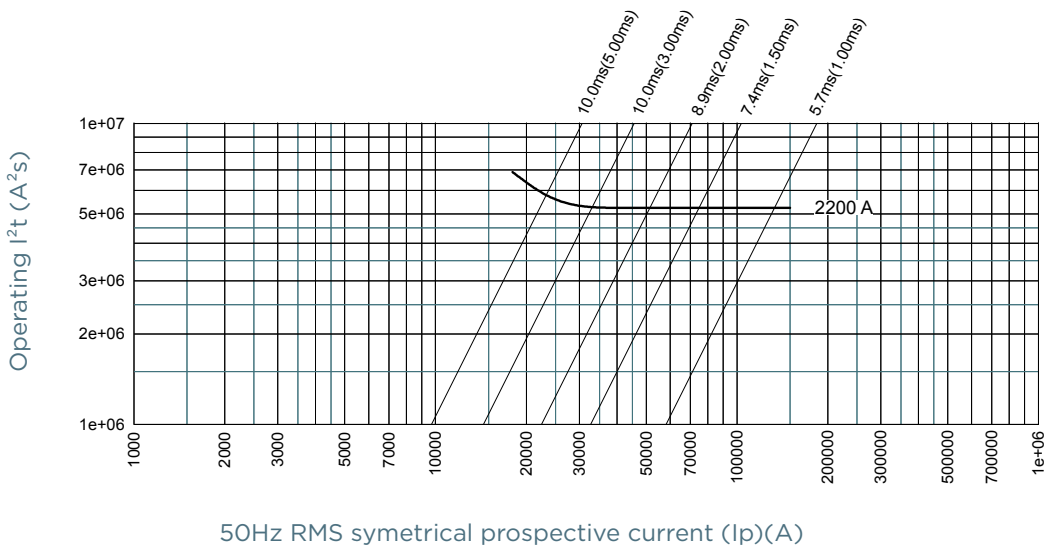

# Protistor® size 2x32 and 2x33 aR

400 to 690VAC (IEC) / 700VAC (UL)

## CHARACTERISTICS TOTAL I<sup>2</sup>T CURVE

### Size 2x32 690V

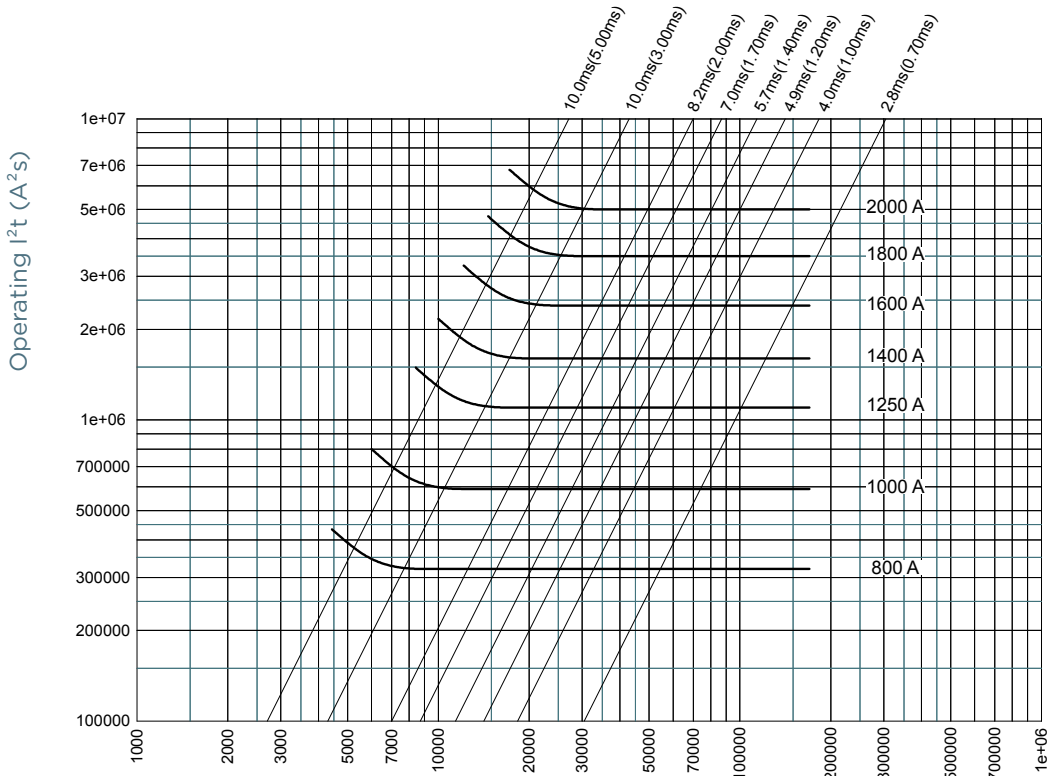

50Hz RMS symmetrical prospective current (Ip)(A)

### Size 2x33 400V

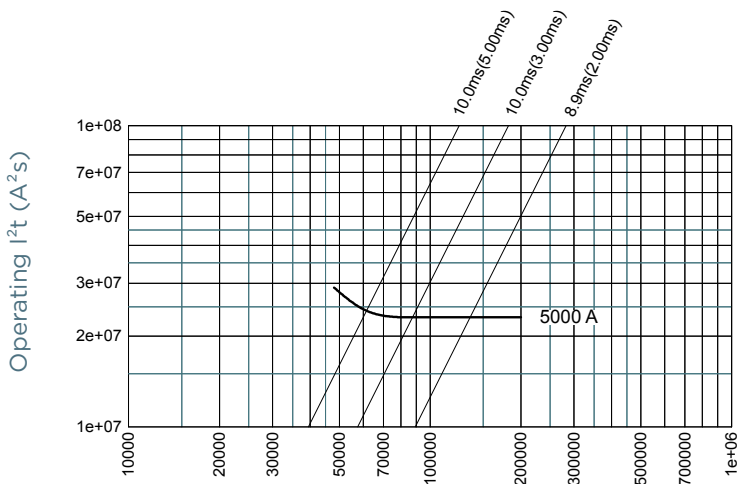

50Hz RMS symmetrical prospective current (Ip)(A)

# Protistor® size 2x32 and 2x33 aR

400 to 690VAC (IEC) / 700VAC (UL)

## CHARACTERISTICS TOTAL I<sup>2</sup>T CURVE

### Size 2x33 600V

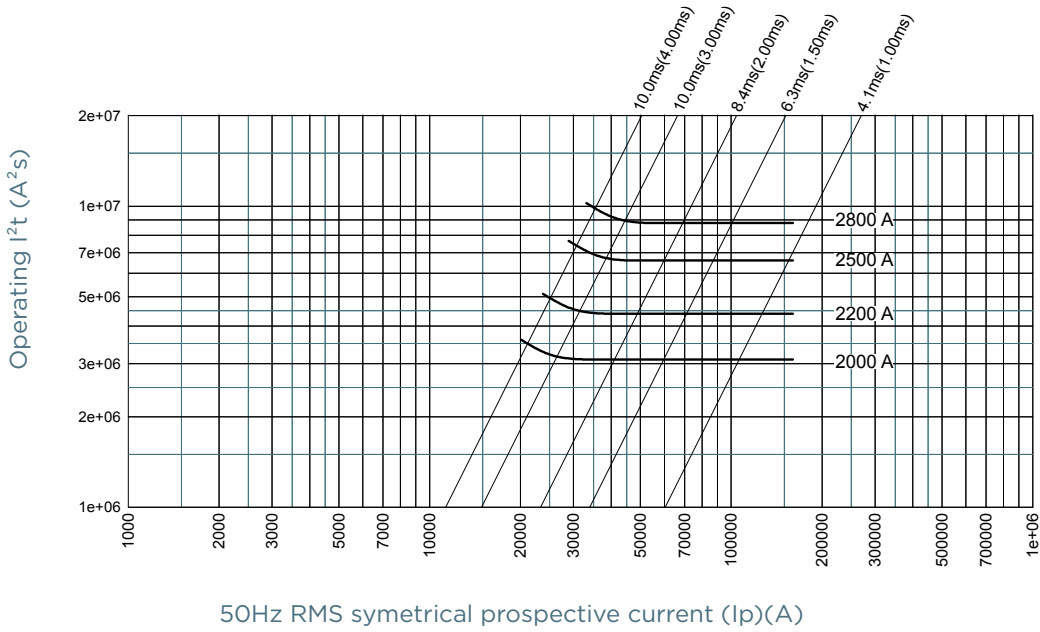

### Size 2x33 690V

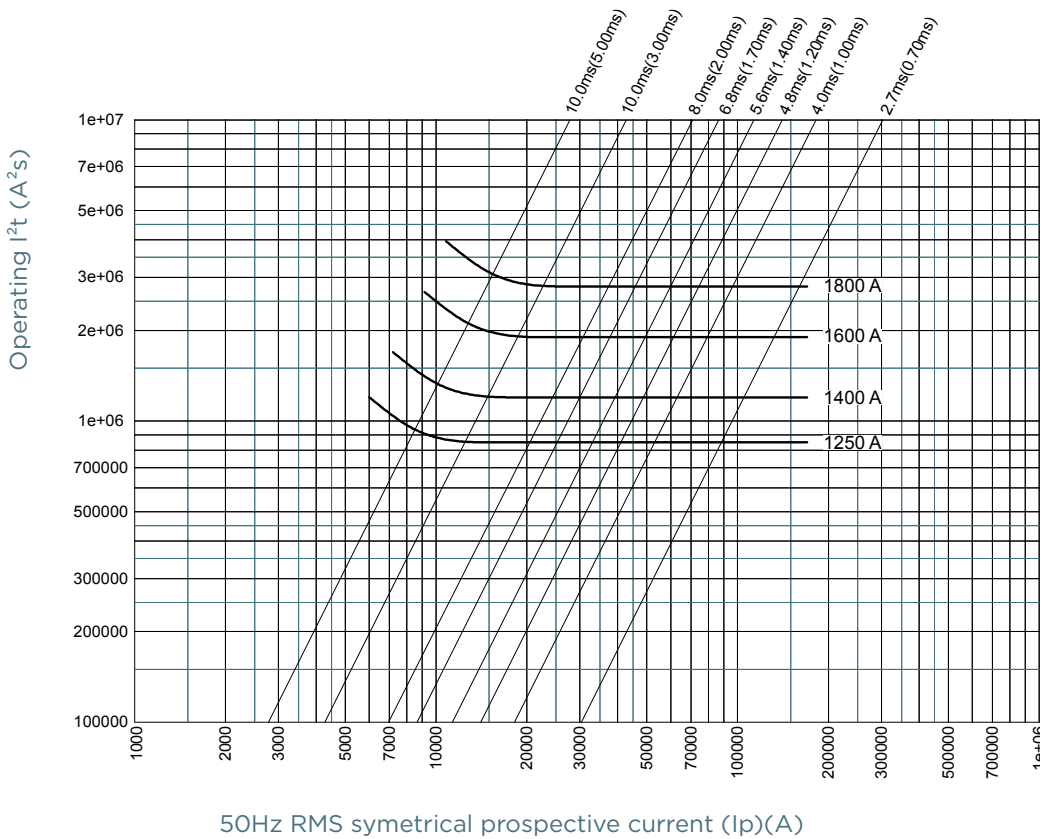

MERSEN reserves the right to change, update or correct, without notice, any information contained in this datasheet.

# Protistor® size 2x32 and 2x33 aR

400 to 690VAC (IEC) / 700VAC (UL)

## POWER DISSIPATION

### Size 2x32

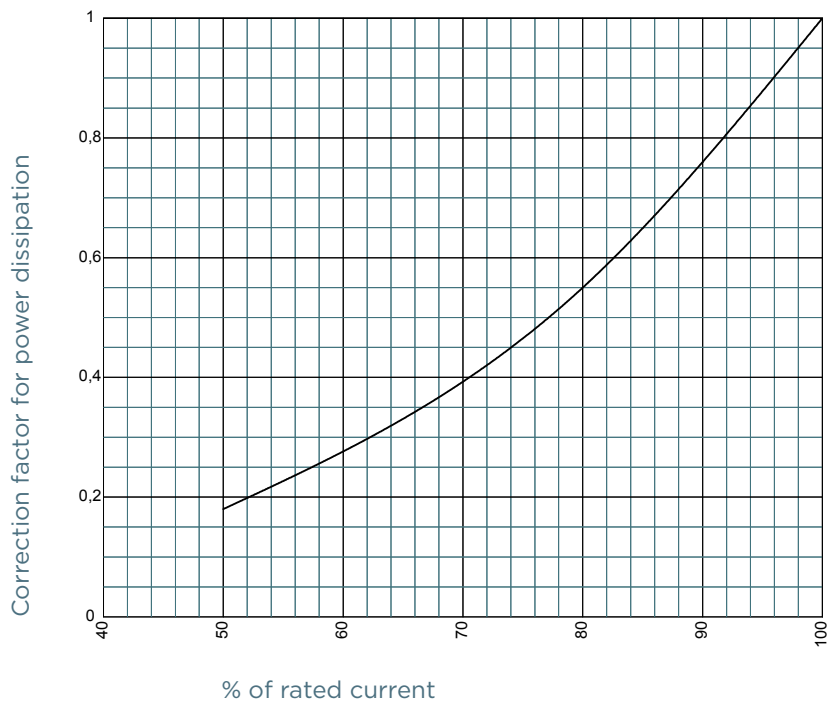

### Size 2x33

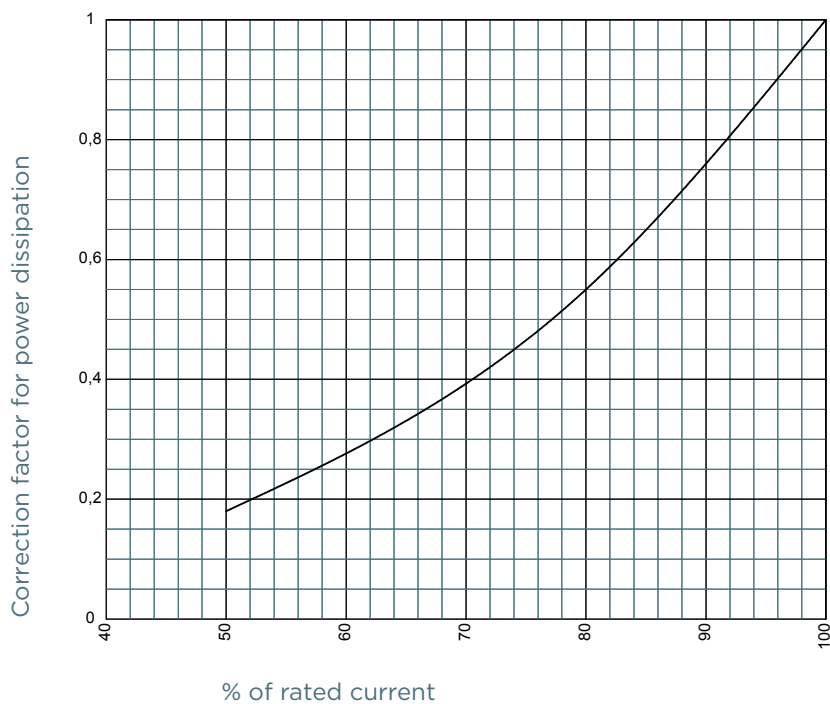

# Protistor® size 2x32 and 2x33 aR

400 to 690VAC (IEC) / 700VAC (UL)

## PEAK ARC VOLTAGE

### Size 2x32

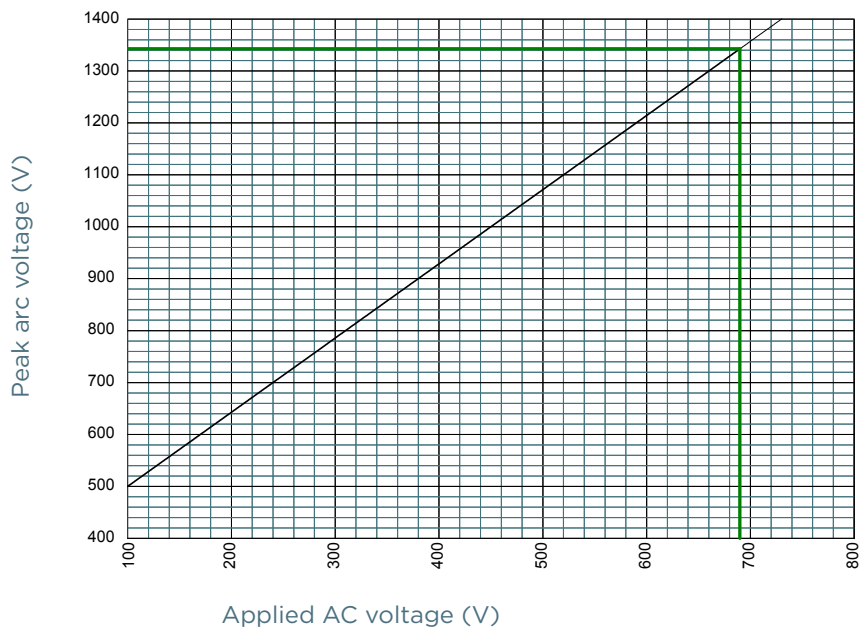

### Size 2x33

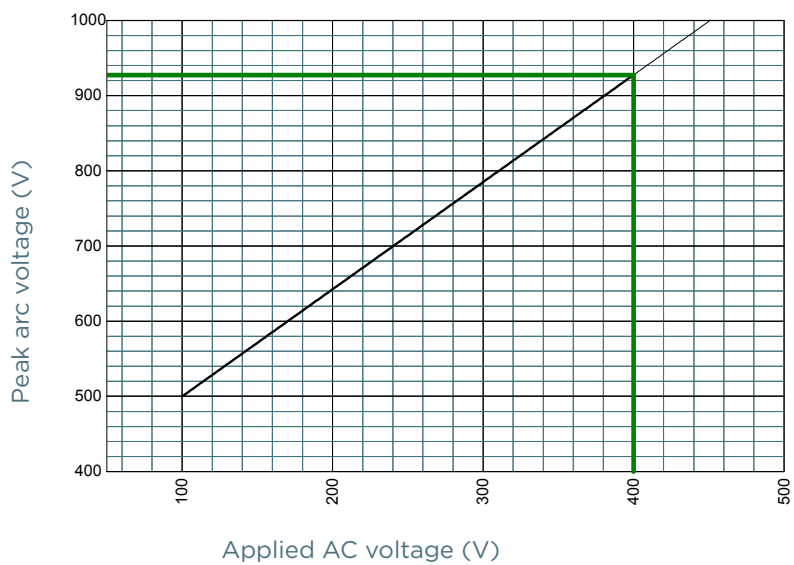

# Protistor® size 2x32 and 2x33 aR

400 to 690VAC (IEC) / 700VAC (UL)

## DIMENSIONS

Size 2x32 aR TTF (102654)

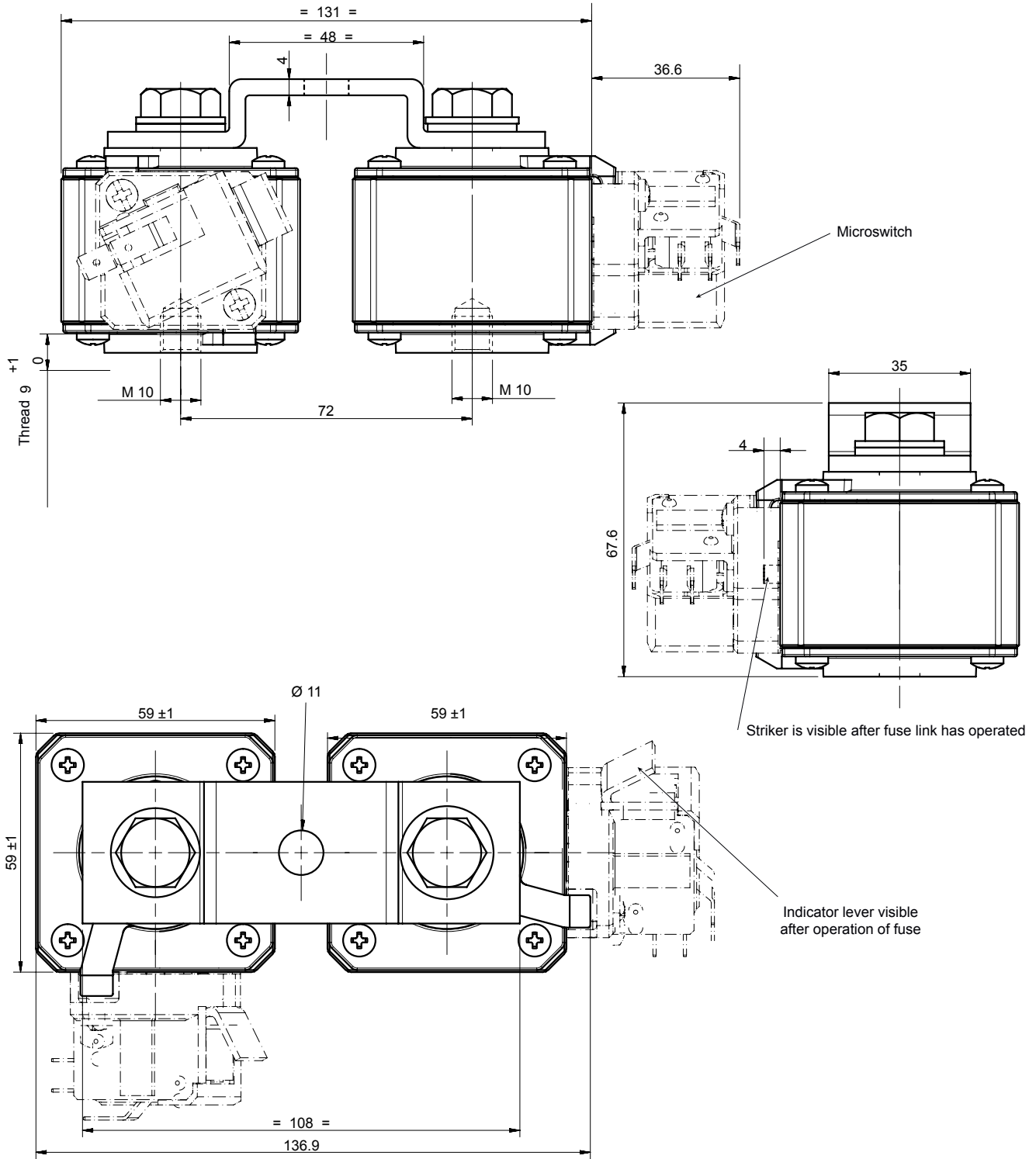

Dimensions in mm

MERSEN reserves the right to change, update or correct, without notice, any information contained in this datasheet.

# Protistor® size 2x32 and 2x33 aR

400 to 690VAC (IEC) / 700VAC (UL)

## DIMENSIONS

Size 2x33 aR PLxF (105252)

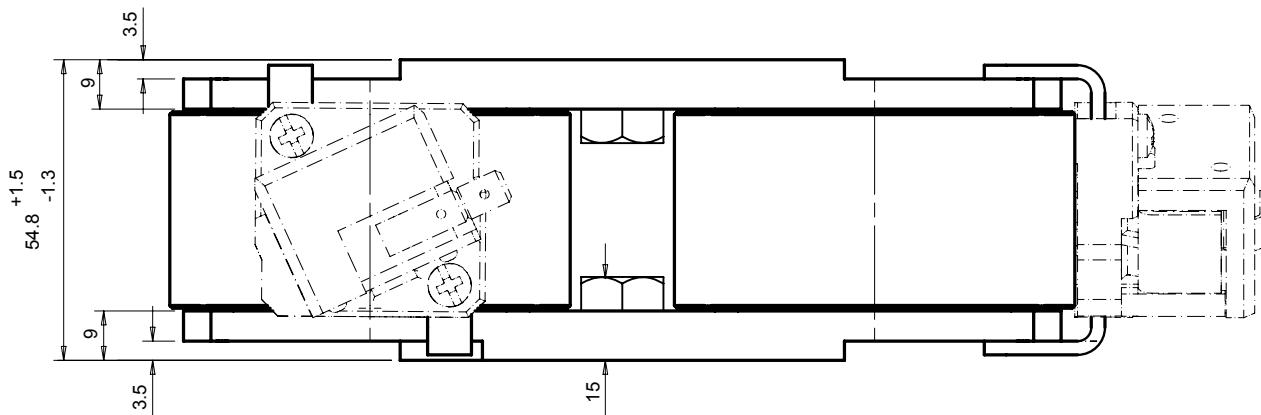
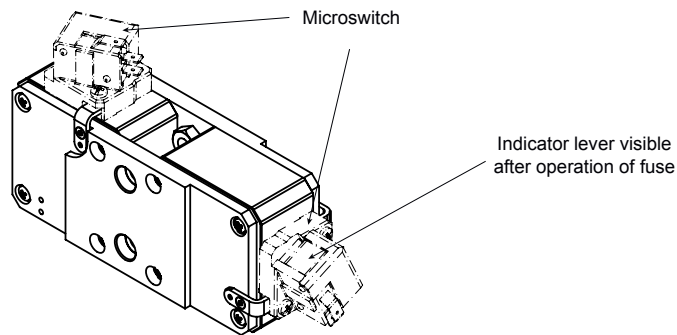
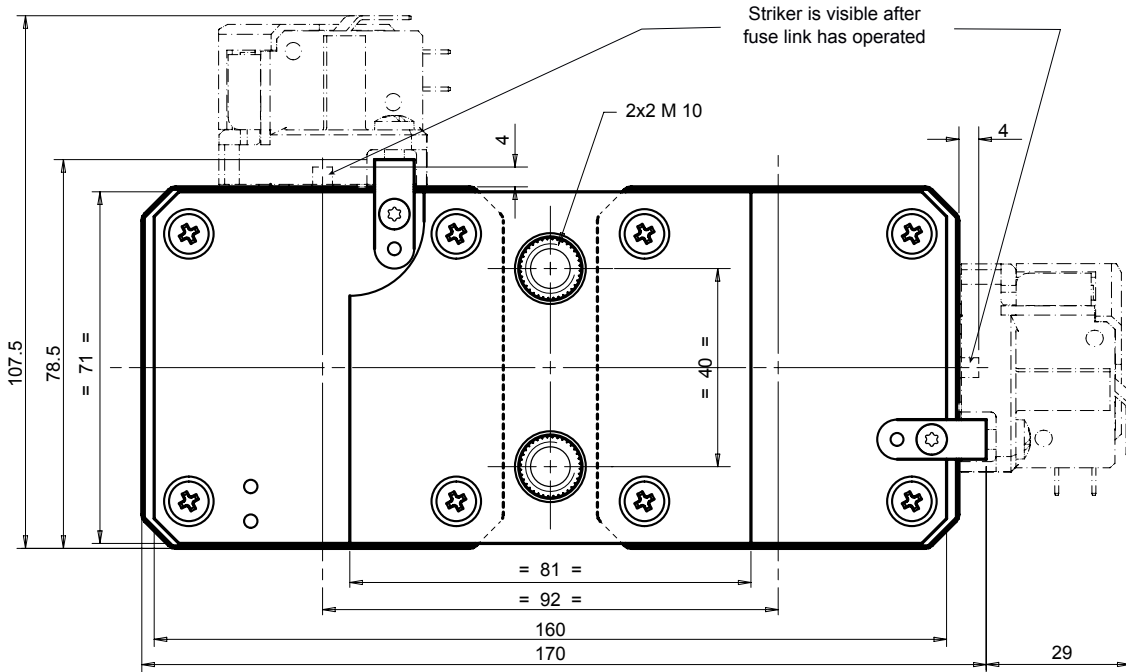

Dimensions in mm

MERSEN reserves the right to change, update or correct, without notice, any information contained in this datasheet.



# Protistor® size 2x32 and 2x33 aR

400 to 690VAC (IEC) / 700VAC (UL)

## DIMENSIONS

Size 2x33 aR TTF (102653)

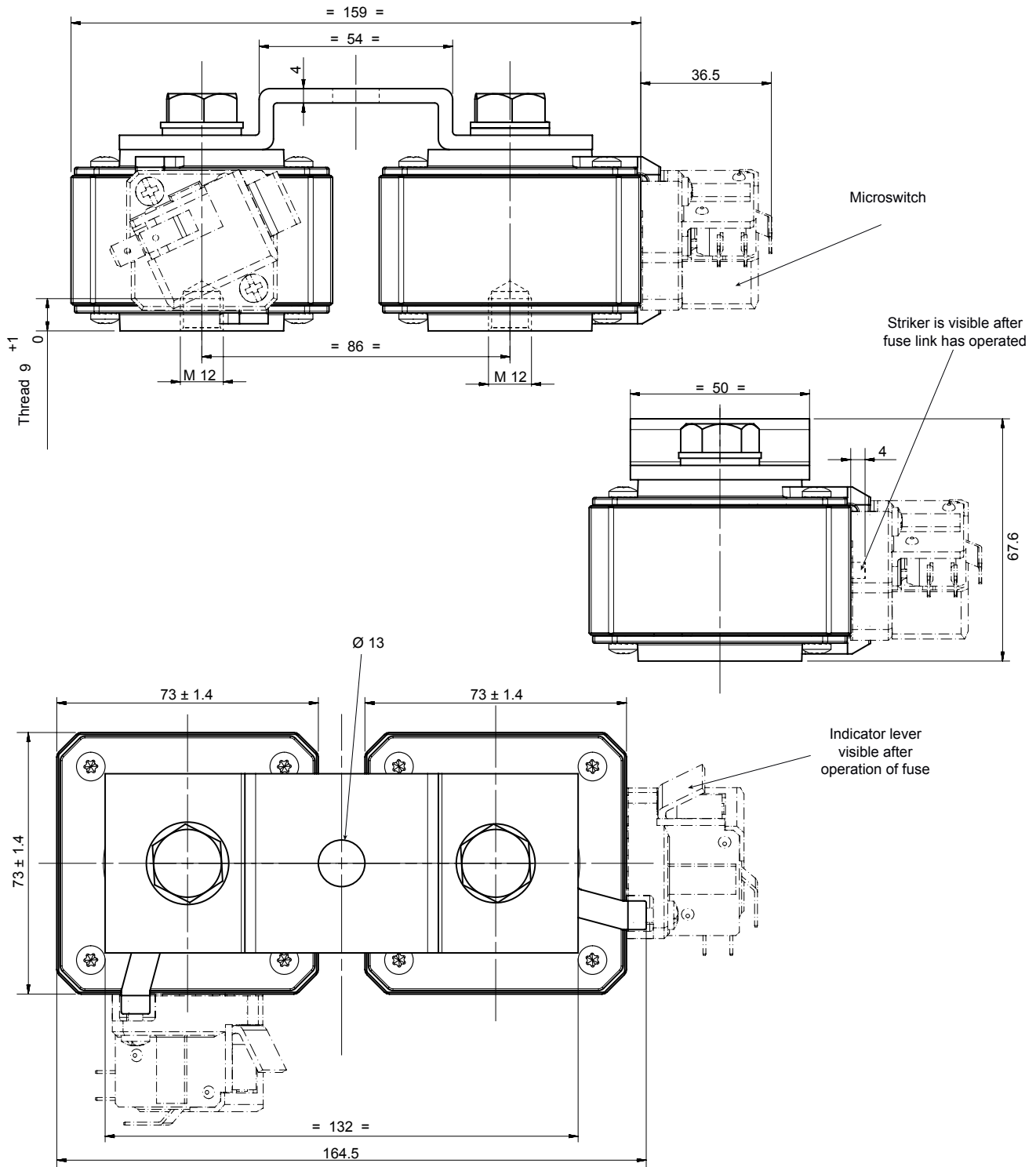

Dimensions in mm

MERSEN reserves the right to change, update or correct, without notice, any information contained in this datasheet.

# Protistor® size 2x32 and 2x33 aR

400 to 690VAC (IEC) / 700VAC (UL)

## APPENDIX

### Index

Catalog number	Item number	Description 1	Page
PC233UD69V13CTF	D300268	6,9 URD 233 TT F 1250	2
PC233UD69V14CTF	E300269	6,9 URD 233 TT F 1400	2
PC233UD69V16CTF	F300270	6,9 URD 233 TT F 1600	2
PC232UD69V8CTF	T300305	6,9 URD 232 TT F 0800	2
PC232UD69V10CTF	T300213	6,9 URD 232 TT F 1000	2
PC232UD69V13CTF	V300214	6,9 URD 232 TT F 1250	2
PC232UD69V14CTF	G300087	6,9 URD 232 TT F 1400	2
PC36UD69V18CP11	B300427	6,9 URD 233 PLAF 1800	2
PC36UD60V20CP11	R302235	6 URD 233 PLAF 2000	2
PC36UD60V22CP11	Q302234	6 URD 233 PLAF 2200	2
PC36UD60V25CP11	P302233	6 URD 233 PLAF 2500	2
PC36UD60V28CP11	N302232	6 URD 233 PLAF 2800	2
PC36UD55V30CP11	L301977	5,5 URD 233 PLAF 3000	2
PC36UD55V32CP11	M301978	5,5 URD 233 PLAF 3200	2
PC36UD50V36CP11	N301979	5 URD 233 PLAF 3600	2
PC36UD50V40CP11	P301980	5 URD 233 PLAF 4000	2
PC36UD45V45CP11	Q301981	4,5 URD 233 PLAF 4500	2
PC36UD40V50CP11	R301982	4 URD 233 PLAF 5000	2